



WECHAT



HOMEPAGE

SHENZHEN DDW TECHNOLOGY CO.,LTD
深圳市乐华多媒体科技有限公司

 **LCD DISPLAY
PRODUCT CATALOG**

TABLE OF CONTENTS

01/02	Company Profile	33/34	> Double Side Series / Door Open Series
03/04	Company Advantages	35/36	> Landscape Floor Stand Series / Floor Stand Frame Options
05/06	Our Production	37/38	> Touch Screen Kiosks / Touch screen kiosk frame options
07/08	Our Customers	39/40	> Indoor Windows display Series / Smart Interactive whiteboard
09/10	LCD Video Walls	41/42	> Configuration / Features
11/16	> UNB Video Wall Models	43/44	> Applications
17/18	> Technolical Specifications / Video Wall Mount Options	45/46	Outdoor Digital Totem
19/20	> Main Features	47/48	> Outdoor Digital Totem / Battery Drive Outdoor Digital Totem
21/22	> Applications	49/50	> Outdoor Digital Totem / Outdoor Digital Totem frame options
23/24	Video Wall Controller	51/52	> Features / Applications
25/26	> Features / Applications	53/54	Stretched Bar LCD / Shelf LCD Screen
27/28	LCD Digital Signages	55/56	> Features / Applications
29/30	> Wall Mount Siries / Floor Standing Siries	57/58	Our Projects / Our Services
31/32	> Ultra Thin Series / LCD Posters Series	59/60	Cooperation Brands / Company Honors
		61/62	Contact Us

About Us

Shenzhen DDW Technology Co.,Ltd started in 2012, a leading manufacturer and developer of commercial LCD displays with own facility 7000sqm in China. We focus on customized Indoor outdoor digital totems, touch screen kiosk, Stretched Bar LCD, LCD video wall system, video wall controller and more LCD display solutions. With high quality standard, meticulous workmanship, strict quality control, professional service, DDW aims to provide our customers, distributors and suppliers with win-win cooperation.

Our Product:

- Indoor digital signage displays
- Outdoor LCD digital totems
- UNB LCD video walls / video wall controllers
- Interactive whiteboard
- Stretched bar LCD displays
- Transparency LCD screen
- Indoor Outdoor LED displays



COMPANY ADVANTAGES

Our Advantages:

- Fast smooth communication
- Free project proposal, design and assessment
- Comprehensive installation advice guidance
- Guaranteed return & replacement policy
- Flexible OEM/ODM customized service
- Competitive price factory drop ship
- Strict QC control and workman ship
- Convenient logistics service
- Alibaba certified trade assurance supplier
- All in one Production department and office

Our Mission

To be a brand company in commercial display industry, with reliable quality products and service in the world.

Our Vision

To establish a well-trusted company in the sphere of digital display, harnessing firm partnerships - sharing relative game in altering conventional to digital metamorphosis.

OUR PRODUCTION



Facilities

We group companies own following facilities:

- 2000m² indoor display factory & office
- 3000m² outdoor factory
- 2000m² panel & metal warehouse

All departments R&D Technical, Purchase, Production (Assemble-QC-Packing-Shipping-After-sales), Domestic & Overseas Sales, Merchandiser and Public Relationship joint corporately & effectively.

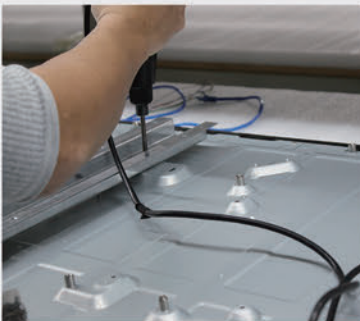
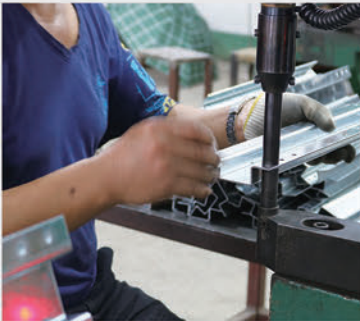



OUR CUSTOMERS

Global communication, international wisdom

At present, export volume of digital products keeps a rapid growth. Our products have sold many countries all over the world, such as USA, Germany, UK, Canada, Spain, Italy, Russia, Australia, Singapore, Malaysia, Japan and so on. Export volume has taken up more than 90% of whole volume. Regarding Digital products, we neither stop nor even hesitate in pursuing superior quality.





LCD VIDEO WALLS

Videowalls are a powerful new way to break through the clutter and engage with your intended audience. DDW pioneered LCD based videowalls and is now the market leader in ultra-thin, eco-friendly, LED-based videowalls. Our complete solution includes a wide range of advanced LED display panels, robust management software, and media players to suit almost any need and budget. videowalls are used by leading retailers, airports, businesses, public venues and educational facilities around the world.

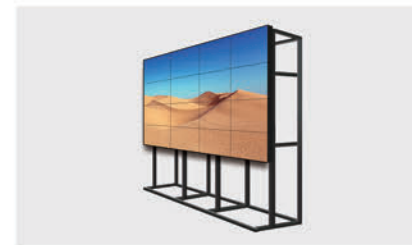

LW460HN09

- LCD Panel: Samsung DID (OFFICIAL MODEL NO. LTI460HN09)
- Active Screen Diagonal: 46" 16:9
- Total Bezel Width: 5.3mm
- Resolution: 1920 x 1080
- Luminance(nits): 500cd/m²
- Active Display Area(WxH): 1018.08x572.67 mm
- Panel Dimension(WxHxD): 1023.98 x 578.57 x 79.5mm

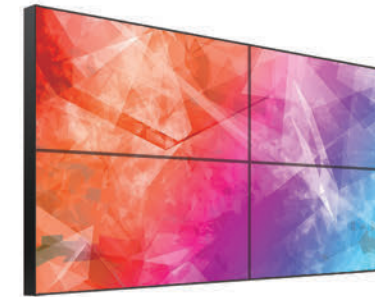

LW460HN11/12





- LCD Panel: Samsung DID (OFFICIAL MODEL NO. LTI460HN11/12)
- Active Screen Diagonal: 46" 16:9
- Total Bezel Width: 3.5mm
- Resolution: 1920 x 1080
- Luminance(nits): 500cd/m², 700cd/m²
- Active Display Area(WxH): 1018.08x572.67mm
- Panel Dimension(WxHxD): 1021.98 x 576.57 x 72.1mm



LW460HN13/14

- LCD Panel: SAMSUNG DID (OFFICIAL MODEL NO. LTI460HN13)
- Active Screen Diagonal: 46" 16:9
- Total Bezel Width: 1.7mm
- Resolution: 1920 x 1080
- Luminance(nits): 700cd/m², 500cd/m²
- Active Display Area(WxH): 1018.08x 572.67mm
- Panel Dimension(WxHxD): 1020.02 x 574.61 x 68.1mm



 100% new Samsung/ LG panel	 Flexible brightness option	 Interactive touch screen available	<p>LED</p> LED backlit
 Ultra-narrow bezel	 178/178 Viewing angles	<p>16:9</p> Aspect Ratio	<p>24</p> 7x24hours (Working time)

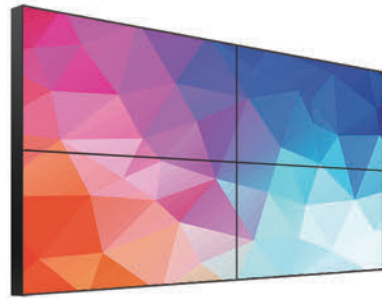

LW460FHM-NV0

- LCD Panel: BOE (OFFICIAL MODEL NO. DV460FHM-NV0)
- Active Screen Diagonal: 46" 16:9
- Total Bezel Width: 3.5mm
- Resolution: 1920 x 1080
- Luminance(nits): 500cd/m²
- Active Display Area(WxH): 1018.08 × 572.67mm
- Panel Dimension(WxHxD): 1021.98 × 576.57 x 59mm



LW550HN11/12

- LCD Panel: SAMSUNG DID (OFFICIAL MODEL NO. LTI550HN11/12)
- Active Screen Diagonal: 55" 16:9
- Total Bezel Width: 3.5mm
- Resolution: 1920 x 1080
- Luminance(nits): 500cd/m², 700cd/m²
- Active Display Area(WxH): 1209.6×680.4mm
- Panel Dimension(WxHxD): 1213.5×684.3 x 67.7mm



LW490DUN-THC4

- LCD Panel: LG IPS (OFFICIAL MODEL NO. LD490DUN-THC1)
- Active Screen Diagonal: 49" 16:9
- Total Bezel Width: 3.5mm
- Resolution: 1920 x 1080
- Luminance(nits): 500cd/m²
- Active Display Area(WxH): 1073.78 × 604mm
- Panel Dimension(WxHxD): 1077.6 × 607.8 x 55.6mm



LW550HN16/14

- LCD Panel: SAMSUNG DID (OFFICIAL MODEL NO. LTI550HN16/14)
- Active Screen Diagonal: 55" 16:9
- Total Bezel Width: 1.7mm
- Resolution: 1920 x 1080
- Luminance(nits): 500cd/m², 700cd/m²
- Active Display Area(WxH): 1209.6×680.4mm
- Panel Dimension(WxHxD): 1211.54×682.34 x 65.1mm

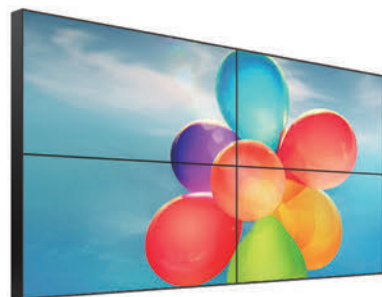

LW490DUN-TJB2

- LCD Panel: LG IPS (OFFICIAL MODEL NO. LD490DUN-TJB2)
- Active Screen Diagonal: 49" 16:9
- Total Bezel Width: 1.8mm
- Resolution: 1920 x 1080
- Luminance(nits): 500cd/m²
- Active Display Area(WxH): 1073.8 × 604mm
- Panel Dimension(WxHxD): 1075.58 × 605.8 x 54.3 mm

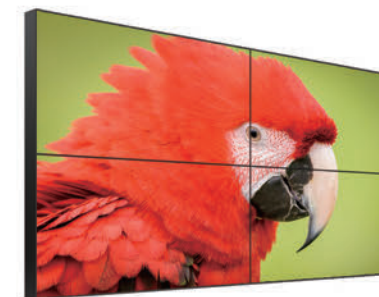

LW550DUN-TKB2

- LCD Panel: LG IPS (OFFICIAL MODEL NO. LD550DUN-TKB1)
- Active Screen Diagonal: 55" 16:9
- Total Bezel Width: 3.5mm
- Resolution: 1920 x 1080
- Luminance(nits): 500cd/m²
- Active Display Area(WxH): 1209.6×680.4mm
- Panel Dimension(WxHxD): 1213.4×684.2 x 56.2mm

UNB LCD VIDEO WALLS



LW550DUN-THB8

- LCD Panel: LG IPS (OFFICIAL MODEL NO. LD550DUN-THB8)
- Active Screen Diagonal: 55" 16:9
- Total Bezel Width: 1.8mm
- Resolution: 1920 x 1080
- Luminance(nits): 500cd/m²
- Active Display Area(WxH): 1209.6×680.4mm
- Panel Dimension(WxHxD): 1211.4×682.2 x 54.3mm

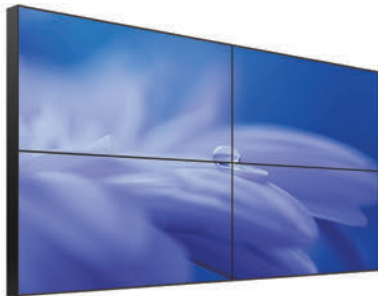

DDW-LW550DUN-TMA2

- LCD Panel: LG IPS (OFFICIAL MODEL NO. LD550DUN-TMA2)
- Active Screen Diagonal: 55" 16:9
- Total Bezel Width: 0.88mm
- Resolution: 1920 x 1080
- Luminance(nits): 500cd/m²
- Active Display Area(WxH): 1209.6×680.4mm
- Panel Dimension(WxHxD): 1210.51×681.22 x 54.3mm

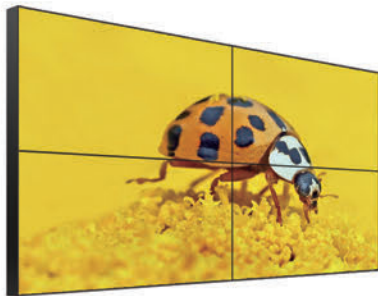

LW650FN01

- LCD Panel: SAMSUNG(OFFICIAL MODEL NO. DV550FHM-NV3)
- Active Screen Diagonal: 65" 16:9
- Total Bezel Width: 3.5mm
- Resolution: 3840 x 2160
- Luminance(nits): 700cd/m²
- Active Display Area(WxH): 1428.48 ×803.52mm
- Panel Dimension(WxHxD): 1432.58 ×807.62 x 54.3mm

REGULAR LAYOUT EXAMPLE

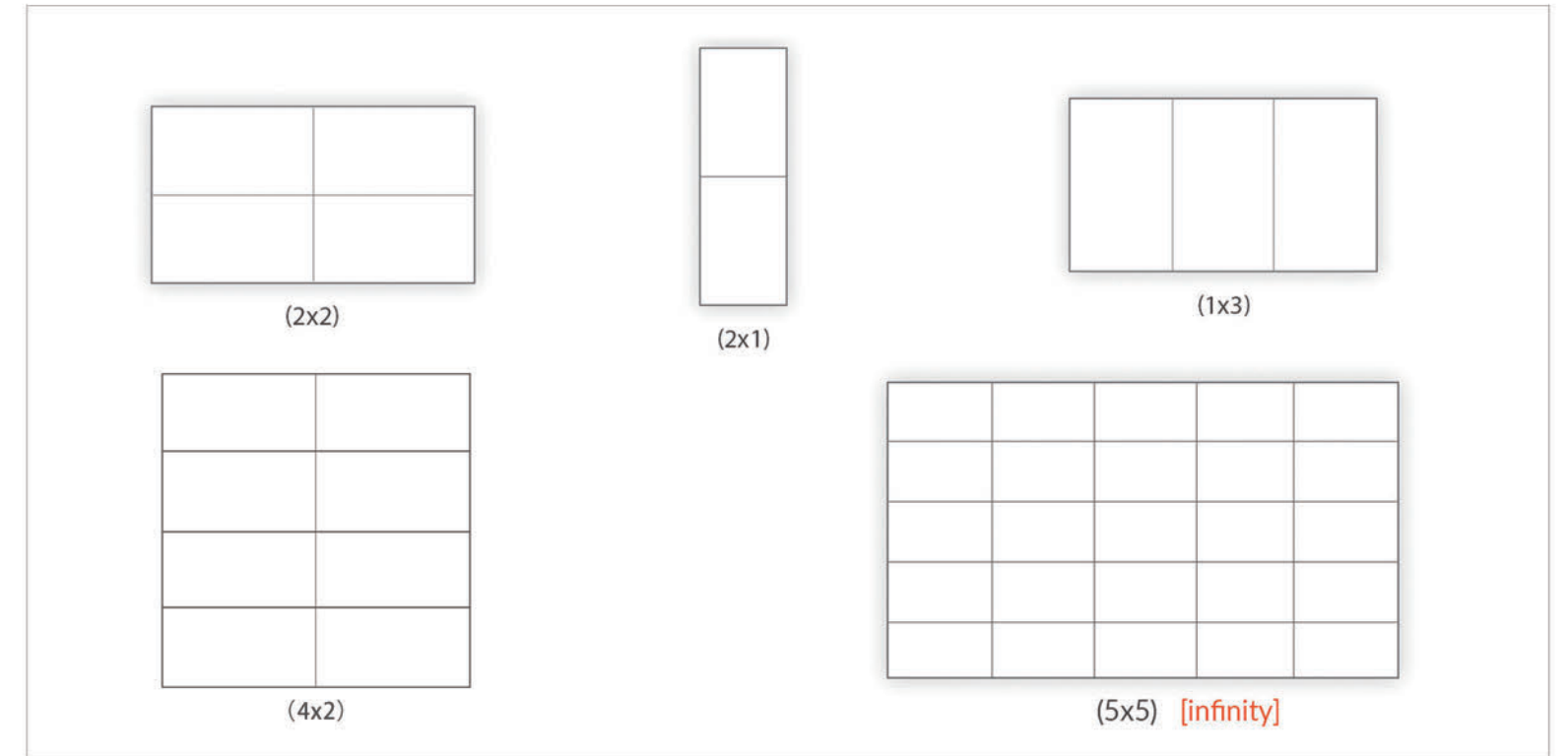

IRREGULAR LAYOUT EXAMPLE

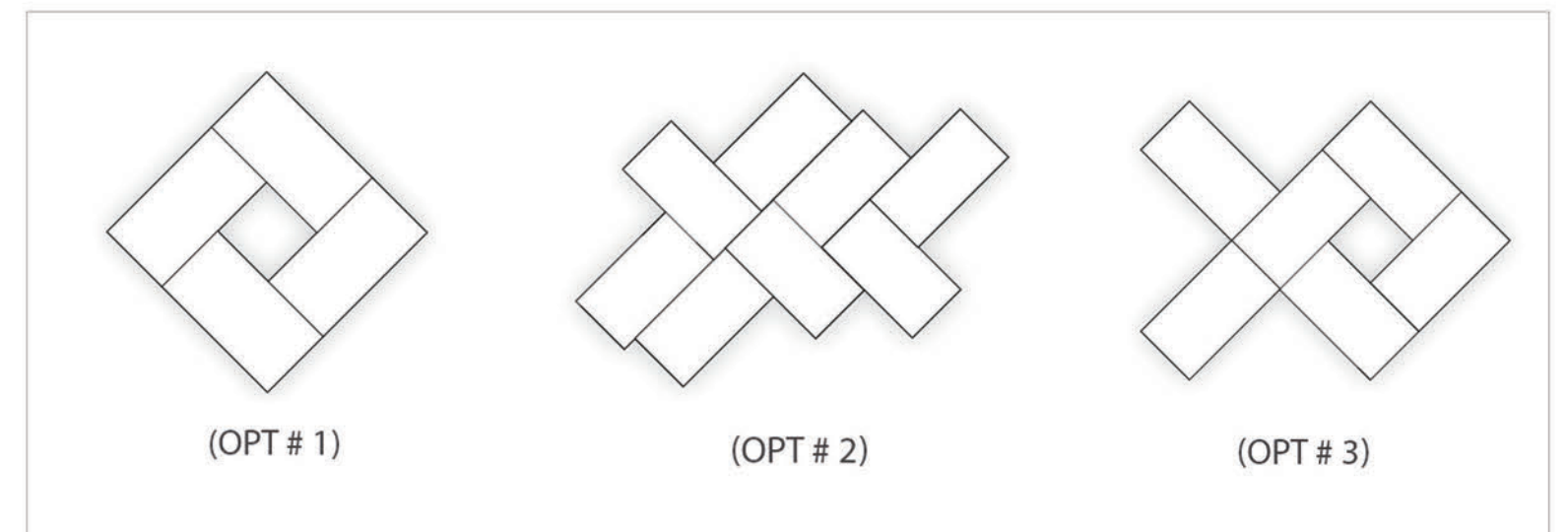



LCD VIDEO WALL TECHNICAL SPECIFICATIONS

Videowall screen Specifications		Controller Inputs, Outputs & Features	
Resolution	1920*1080	Input options	1xHDMI, 1xDVI, 1xVGA, 1xAV
Pixel Pitch	0.63x0.63mm	Output options	1xHDMI, 1xDVI, 1xVGA
Light Source	WLED	RS232 IN	1
Contrast Ratio	1200:1-4000:1	RS232 OUT	1
Color Capability	8Bit,16.7M	IR IN	1
Response Time	<=6ms	AC IN	AC100-240V
Viewing Angle	H 178° V 178°	Color System Support	PAL/NTSC/SECAM
Refresh Rate	60Hz	Control Type	IR Remote & Software Control
Operating Life	>60,000(hrs)	Menu Language	English/Chinese(Multiple Language can be customized)
MTBF	> 100,000 h	Vertical/Horizontal Display	Support
Surface	Anti-glare	Combine Display	Support combine any horizontal & vertical numbers of screens and show display by protocol
Standby Power	<3W	Multiple Interfaces	Support DVI,HDMI,VGA,AV & multiple signal input/output loop
Maximum Power	≅200W	Rich Resolution	Support 1080P,1080I,720P,480P & multiple resolution inputs
Power Supply	AC100~240V 50/60 HZ		
Application Area	Indoor/Semi Outdoor		
Working Temperature	0°C~50°C		
Storage Humidity	85% non-condensing		

VIDEO WALL MOUNT OPTIONS

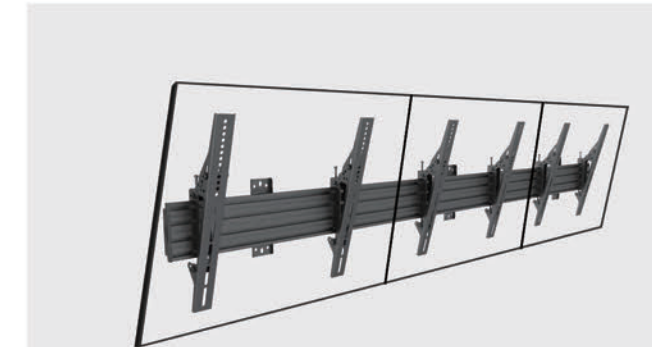

1 | Wall Mounting

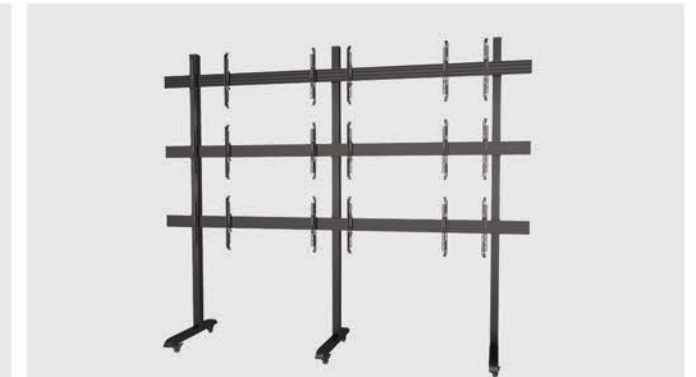

2 | Free Standing

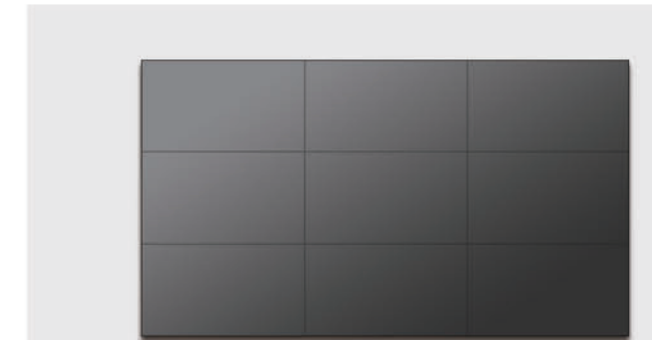

3 | Wall Mounting



4 | Floor Standing



5 | Floor Standing Cabinets



6 | Front Push Hydraulic Pop Out

DIAGRAM

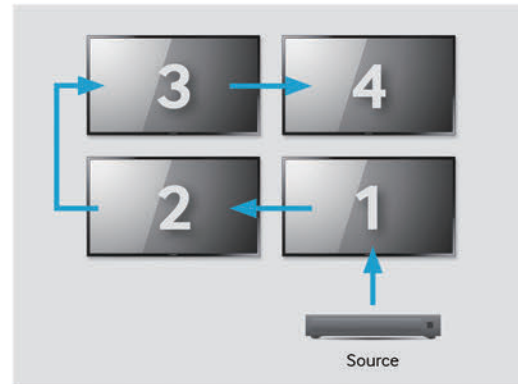

Basic Content Playback Using On-Board Processors and Storage

For basic video playback, simply use the on-board processors and storage in the videowalls to daisy chain up to 100 displays. These displays use DisplayPort connectors to daisy chain the video loop from one source panel. It is a cost-effective solution for deployments that may not need complex features.

Live Streaming and Large-Scale Deployments with VideoWall Software

For deployments with more than 16 panels or additional functionality, the VideoWall software and associated hardware is ideal. The VideoWall software enables live camera feeds and controls up to 250 displays. This option is ideal for large videowalls, conference rooms and control rooms where the ability to display PC and camera feeds may be required, in addition to providing flexibility of rotating or overlapping your screens.

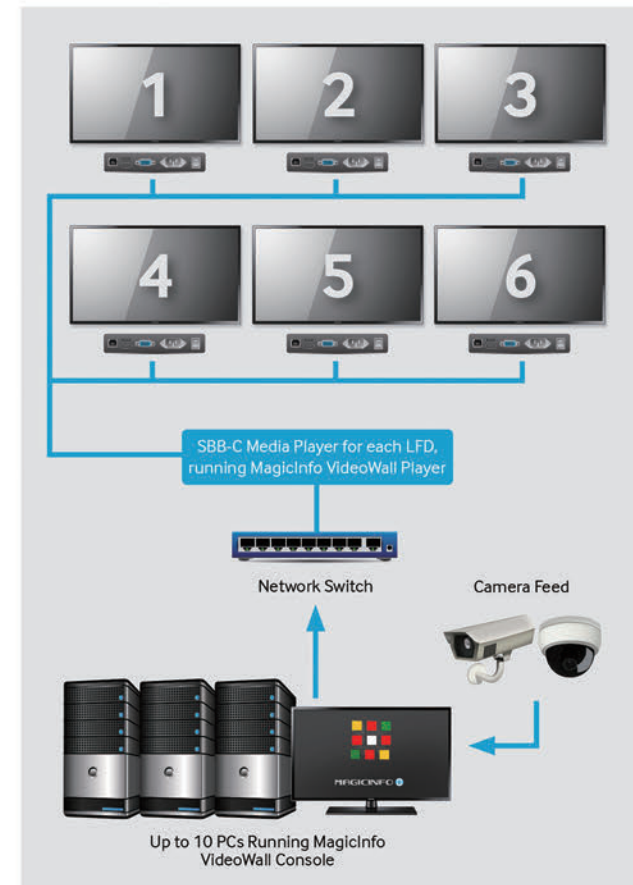

MAKE A BIG IMPRESSION THROUGH CLEAR, COMPELLING VIDEO WALL CONTENT

Increased competition for consumers' attention, often in tight, crowded environments, has forced businesses to move away from traditional static and analog signage and toward more modern, eye-catching alternatives. In turn, video walls have emerged as a go-to upgrade for businesses in various markets and settings who want bigger and better communication. From airports listing real-time flight data to retailers demonstrating new products, video walls are a hub for powerful information delivery.



Impress Visitors at Your Business Facility

Ideal For:

- Department Stores
- Boutiques and Specialty Retail
- Shopping Malls
- Movie Theaters
- Themed Restaurants and Clubs
- Bank Branches and Investment Centers



Engage Viewers in Public Spaces

Ideal For:

- Stadiums and Arenas
- Alumni Centers
- Building Entrances
- High-Profile Areas
- Student Unions and Common Areas
- College Museums and Performing Arts Centers



Entice Customers at Retail Venues

Ideal For:

- Department Stores
- Boutiques and Specialty Retail
- Shopping Malls
- Movie Theaters
- Themed Restaurants and Clubs
- Bank Branches and Investment Centers



Connect with Students and Alumni

Ideal For:

- Stadiums and Arenas
- Alumni Centers
- Building Entrances
- High-Profile Areas
- Student Unions and Common Areas
- College Museums and Performing Arts Centers

Varsity Football Schedule

Week	Date	Opponent	Location	Time
scrimmage 1	August 24	Cougars	Away	7:00pm
0	September 1	Lions	Away	7:30pm
1	September 7	Mustangs	Home	8:00pm
2	September 14	Tigers	Away	7:30pm

District 17 AAAA

3	September 21	Bears	Home	7:30pm
4	September 28	Longhorns	Away	7:30pm
5	October 5	Thunderbirds	Away	7:30pm
6	October 12	Bulls	Home	7:30pm
7	October 19	Mustangs	Home	7:30pm
8	October 26	Cougars	Away	7:30pm
9	November 2	Lions	Home	7:30pm
10	November 9	Longhorns	Away	7:30pm

Homecoming - October 12 • Senior Night - November 2

VIDEO WALL CONTROLLER



Input	CVBS	Support PAL/NTSC format, multiple BNC ports
	VGA/RGBHV	Multi-channel VGA DB-15 port, support VGA full-format input
	HDMI/DVI/4K-DVI/IP	Support 4K(3840x2160) input, each IP decode 4 channels
	YPbPr/YCbCr(customizable)	The same connector of VGA/RGBHV signal, support PAL/NTSC format and 720p/1080i HSTV
	SDI(customizable)	BNC Port
Output	VGA/RGBHV	Signal channel XGA(1024x768@60Hz)/DB-15 port
	HDMI/DVI	HDMI DVI output
	SDI(Customizable)	BNC port loop out
Control	Standard RS232 port	
	IR remote control (Customizable) / LAN control / IOS, Android APP control (optional)	
Working temperature	-20 C ~60 C	
Working humidity	5% ~ 95%	
AC supply voltage	AC100V - 240V 50Hz/60Hz	
Power consumption	The maximum consumption for each channel is 15W	



DDW Video Wall Controller is a full hardware DSP architecture products, with a flexible modular design, Input and output card board with a flexible, it can support input of a variety of interfaces and signal source. In addition to standard features, there are matching features, such as pre-monitoring, echo function, input and output characters display with superimposed.

1 Single-screen multi-window any super-roaming

Single-screen support multi-window various types of signal superposition, roaming, window display.



4K UHD

2 Support ultra-high-definition 4K signal acquisition

You can collect various types of DL-DVI, DP, HDMI1.4 4K signal, providing more shocking and clear display.

3 Pure hardware architecture board any combination

Industrial chassis with CPCI structure. Modular design, dual backup redundant power supply support hot backup, fan and other modules at will. Can support the system processing module hot-swappable, provide various types of chassis and board, for customers to save costs.



4 Multi - group video wall management

Can be several groups of mosaic wall management, mosaic wall between the common input signal source, the output without interference with each other, you can set a different resolution, adjust the color and other parameters.



5 Support PC and mobile control software pre-monitoring display



Support the user in the PC and the mobile side of the control software for all input signals in real-time preview, you can more intuitive choice need to operate the signal source. At the same time in the interface can watch large-screen real-time echo images, improve the efficiency of the operator and prevent the wrong operation.



Support iOS / Android APP control



6 Integrated control function

Integrated control serial port control interface. Can be transferred out RS232, RS485, DMX512 type command, control the projector, large screen switch, curtain lift and so on.



Video wall controller diagram

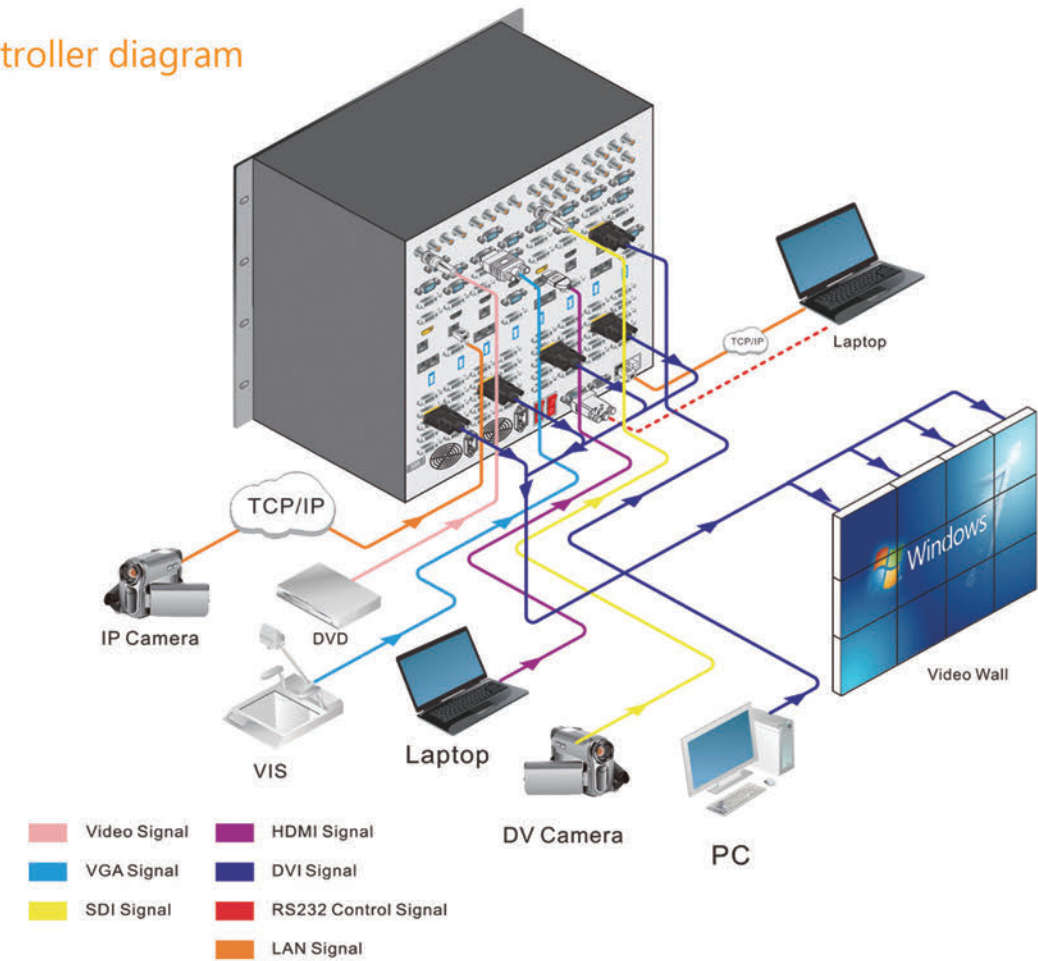

Typical Applications

Monitoring | Command And Scheduling Systems | Public Security | Railway | Military | Meteorological | Aviation





LCD DIGITAL SIGNAGES

DDW's displays combine the visual power of its signage with the touch-driven efficiency of its interactive offerings to better serve the needs of retail, public, corporate and transportation environments, among others. The displays allow consumers to seamlessly navigate a range of relevant content without interference from surrounding light or environmental conditions. The integrated, powerful operating system grants users exciting capabilities to deliver rich, engaging content with minimal operational burden required. Beyond a potential uptick in sales and engagement, businesses also benefit from the reduced total operational costs that come with a low-maintenance, hassle-free visual display upgrade.

WALL MOUNT SERIES

Size: 10" - 98"

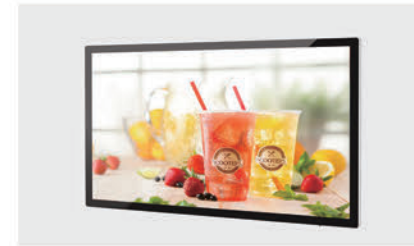
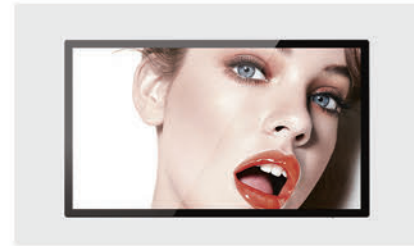

ULTRA THIN SERIES

Size: 32", 43", 49", 55", 65"

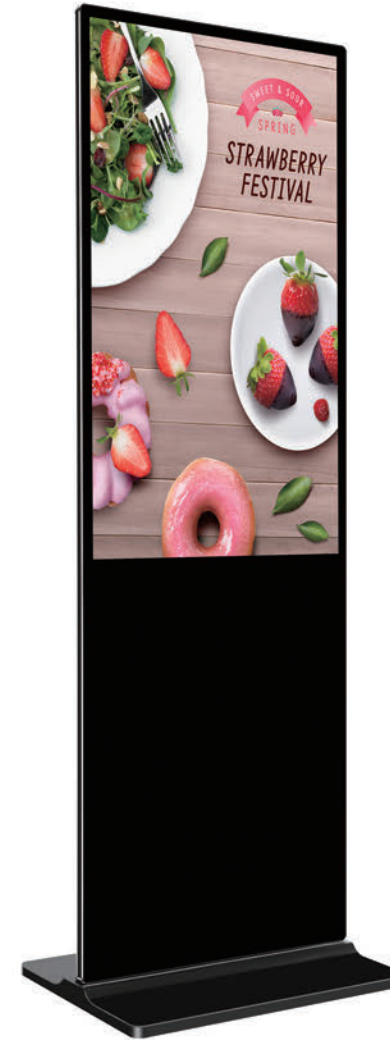

 LG/SAMSUNG FHD screen

 Android/Windows OS optional

 450-1000nits

 Various touch technology optional

 Ultra-thin body

 Google Store
GOOGLE STORE

 Flexible modules optional

 Wheels optional

 LG/SAMSUNG FHD screen

 Android/Windows OS optional

 Various touch technology optional

 Horizontal screen/vertical screen

 GOOGLE STORE

 450-1000nits

 WiFi

 Bluetooth



FLOOR STAND SERIES

Size: 21.5" - 98"



HD
LG/SAMSUNG FHD screen

Android/Windows OS optional

450-1000nits

Various touch technology optional

OEM/ODM
Customizable

Horizontal screen/
vertical screen

Flexible modules optional

Wheels optional



LCD POSTER SERIES

Size: 32", 43", 49", 55", 65"



HD
LG/SAMSUNG FHD screen

Android/Windows OS optional

450-1000nits

Various touch technology optional

Google Store
GOOGLE STORE

A/C power free

Battery power supply optional

Easy to carry



DOUBLE-SIDED SERIES

Size: 43", 49", 55", 65"



HD
LG/SAMSUNG FHD screen

Android/Windows OS optional

450-1000nits



Various touch technology optional

OEM/ODM
Customizable

Door open (Ultra-thin double-sided)

Flexible modules optional

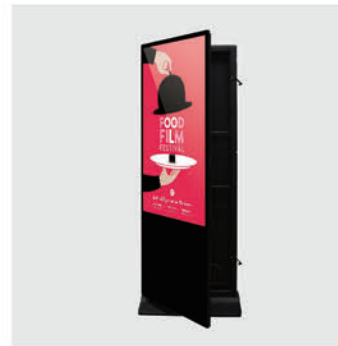
Wheels optional



DOOR OPEN SERIES

Size: 43", 49", 55", 65", 75", 86"



HD
LG/SAMSUNG FHD screen

Android/Windows OS optional

450-1000nits



Various touch technology optional

OEM/ODM
Customizable



Door open (easy maintenance)

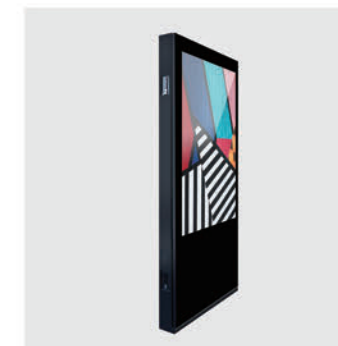





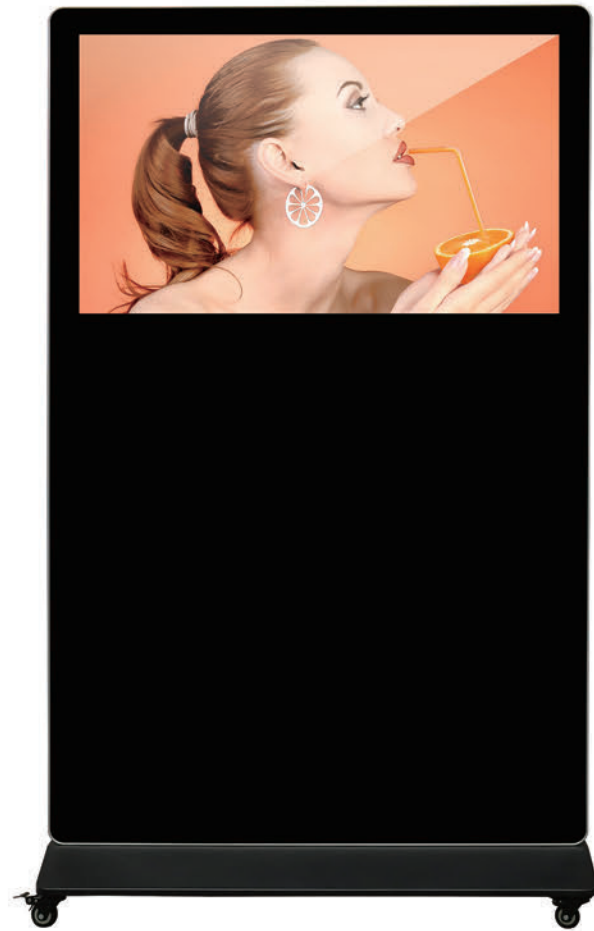

Flexible modules optional



Single/Double side optional



LANDSCAPE FLOOR STAND SERIES Size: 43"- 98"

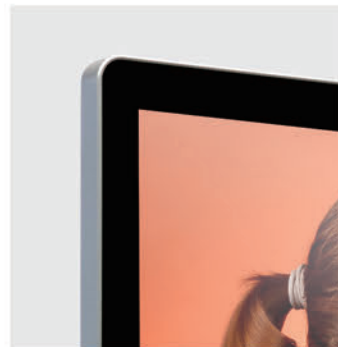
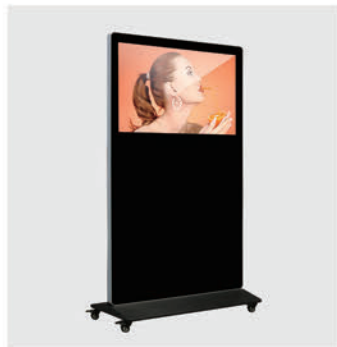

-  LG/SAMSUNG FHD screen
-  Android/Windows OS optional
-  450-1000nits
-  Various touch technology optional
-  Horizontal screen/vertical screen
-  **OEM/ODM**
Customizable
-  Flexible modules optional
-  Wheels optional



• Floor stand frame options

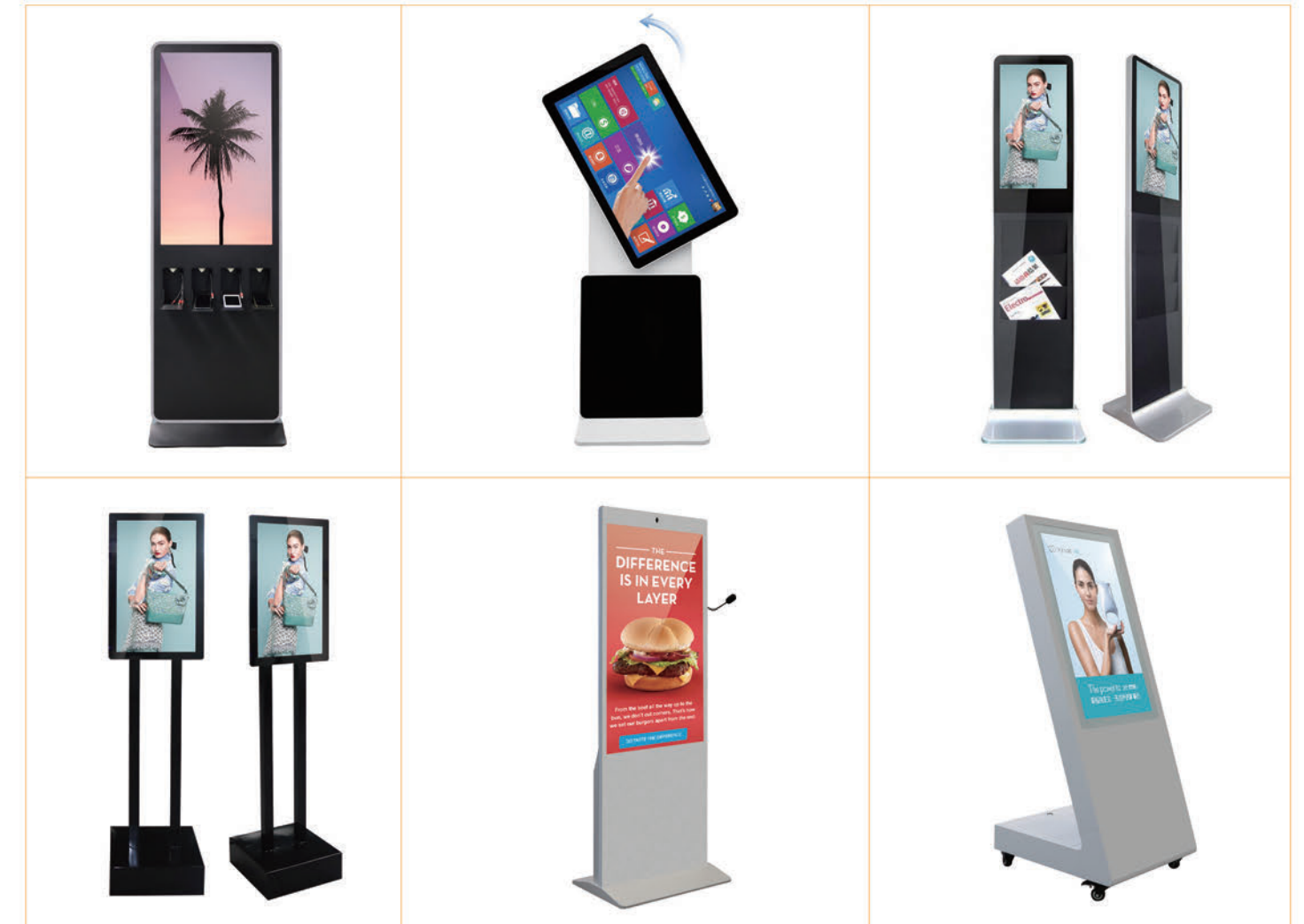

- 1, Appearance, structure and border color can be customized.
- 2, Multiple sizes can be chosen.(21.5",32",43",49",55",65",70",75",86",98")
- 3, More Brightness and modules optional, wheels optional , OEM/ODM welcome.
- 4, Andriod OS support Google store, HDMI input.
- 5, Windows: i3 i5 i7 various generations available.

TOUCH SCREEN KIOSKS

Size: 21.5", 32", 43", 49", 55", 65"



HD
LG/SAMSUNG FHD screen

Android/Windows OS optional

WiFi

Various touch technology optional

450-1000nits

OEM/ODM
Customizable

Flexible modules optional

K/S
K/S shaped base optional



• Touch screen kiosk frame options



- 1, Appearance, structure and border color can be customized.
- 2, Multiple sizes can be chosen.(21.5",32",43",49",55",65",)
- 3, More Brightness and modules optional, wheels optional , OEM/ODM welcome.
- 4, Android OS support Google store, HDMI input.
- 5, Windows: i3 i5 i7 various generations available.

HAND SANITIZING LCD KIOSK

Size: 21.5"



Full HD 1080P



WiFi



Ultra thin design



Flexible modules optional



Android/Windows OS optional



Standing or wall mounted



Single/Double side optional



Customizable

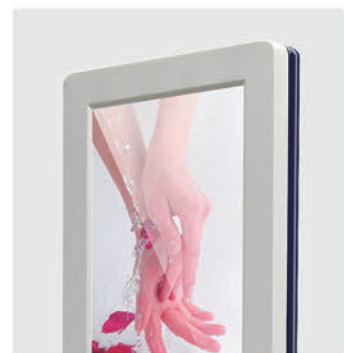

TEMPERATURE SCAN KIOSK

Size: 8"

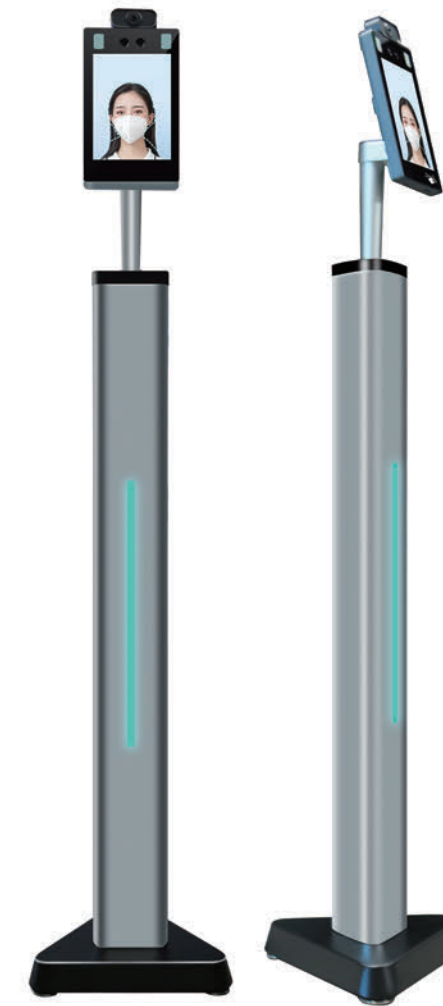

8 inch IPS screen



Wear mask recognizable



video conference



Live detection



Standing or desktop



IR / PCAP touch technology optional



Writing synchronization



Anti-glare

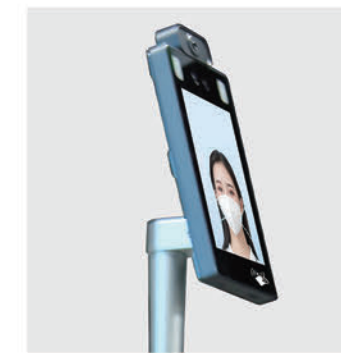

INDOOR WINDOWS DISPLAY SERIES

Size: 43", 49", 55"

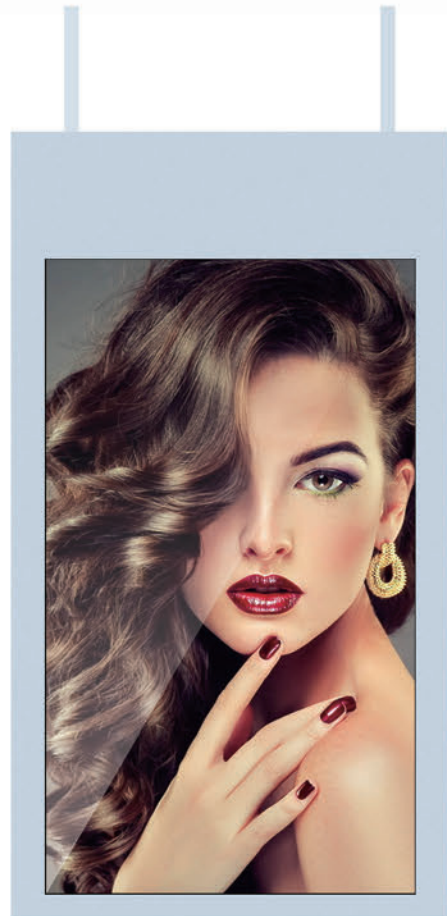

- LG/SAMSUNG FHD screen
- Android/Windows OS optional
- WiFi
- High brightness UP to 2000nits
- Ultra thin design
- Single/Double side optional
- Flexible modules optional
- OEM/ODM**
Customizable

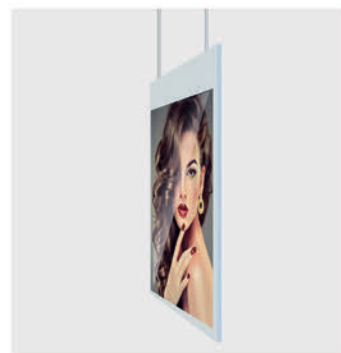
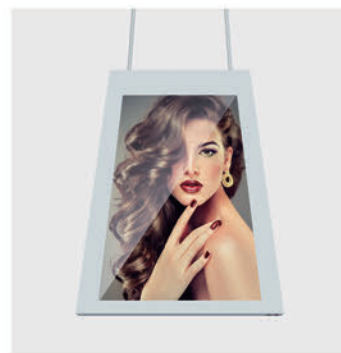
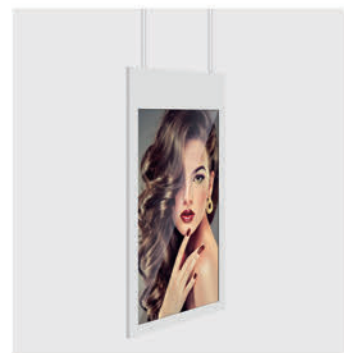

SMART INTERACTIVE WHITEBOARD

Size: 55", 65", 75", 86"

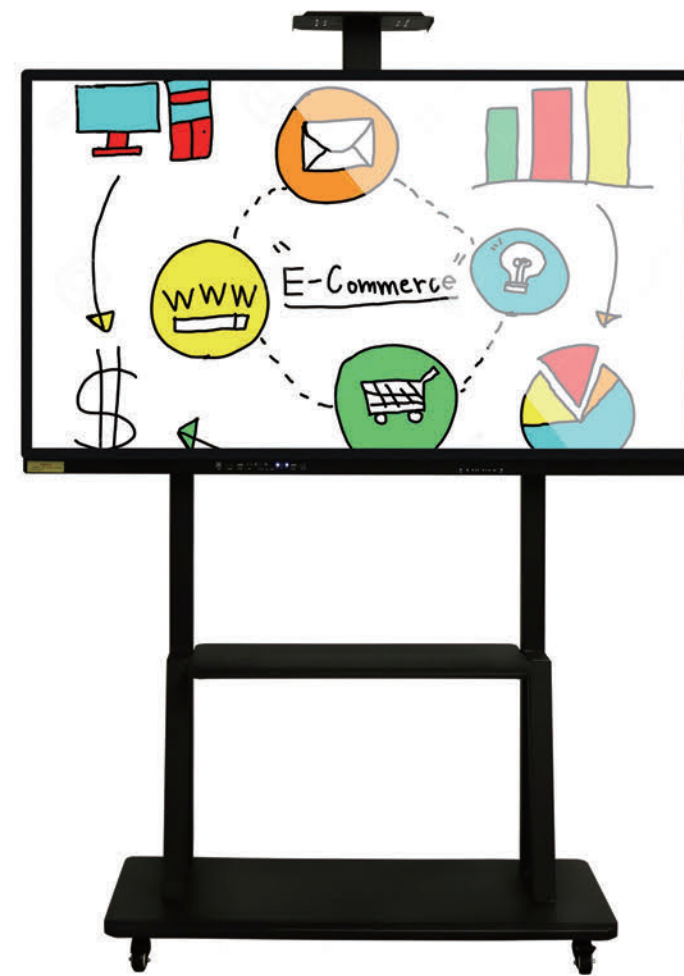

- LG/SAMSUNG FHD screen
- Android/Windows OS optional
- Rich interfaces optional
- IR / PCAP touch technology optional
- video conference
- Writing synchronization
- Wireless input to screen
- Various support rack available





LCD DIGITAL SIGNAGES

Browse our selection of LED backlit display monitors, available in a variety of sizes and specs to match the unique demands of your environment.

Configuration for LCD digital signages are available as follow:

Configuration (optional)	Android Network version	(Qual/dual core 4G/8G internal memory, HDMI,VGA input/output, USB, SD slot, WIFI, LAN, 3G/4G optional)
	Standalone version	HDMI, VGA input, USB, SD slot, 4GB internal memory
	PC version	i3/i5/i7 4G/8G/16G RAM 500GB HDD, WIN7 OS, flexible config
General Information	Program Update	Manual update
	Playlist	YES
	Break-point Memory	YES
	Speaker	YES, 2 x 2W and 2 x 5W optional

LCD DIGITAL SIGNAGE FEATURES

1 Enhanced Connectivity

Through its diverse interface, the signage lets you connect more than one device for optimal use.

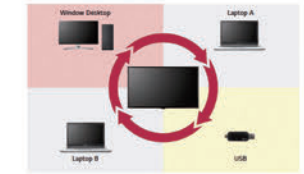

* SNMP: Simple Network Management Protocol

2 Wi-Fi Support

LCD digital signages supports Wi-Fi USB dongle connection for convenient content distribution. And SNMP support ensures convenient network management.

3 Aspect Ratio Sustainability*

Sustain the same resolution and picture quality while powering on/off by receiving EDID1 through switch IC.

1) Extended Display Identification Data.

* Installation Menu > LCD Digital Signage > PM Mode

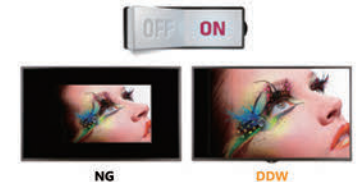

4 Stand-by Screen*

Even without signal from the media player, the network does not turn off completely, so remote control is possible, which prevents unnecessary power usage and enables efficient management.

5 10 Point Multi-Touch

It provides a more realistic interactive sense with ten simultaneous touches.





FSD | Floor standing display

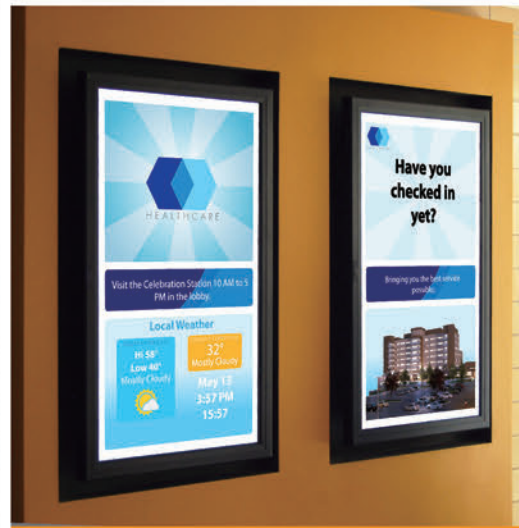

WMD | Wall Mount Display



CCD | Customizable Case Display



Applications

Hotels | Banking | Corporate | Educational Campuses | Shopping centers | Retail Outlets



OUTDOOR DIGITAL TOTEM

Size: 49" - 98"

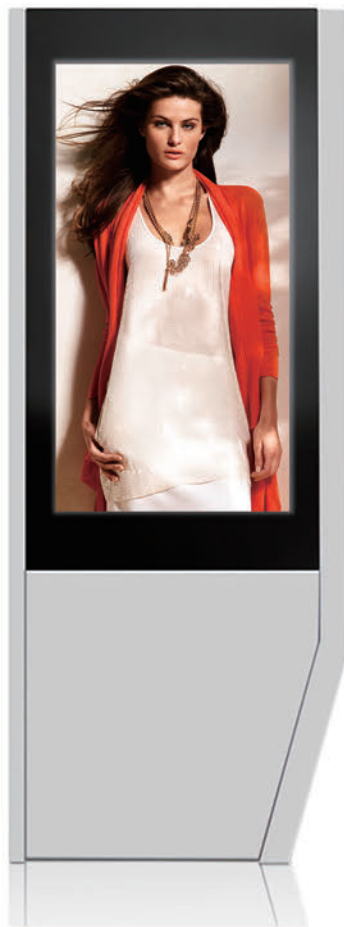

2000-3500nits
brightness panel



Android/Windows OS
optional



-40 C- 55 C working condition

OEM/ODM

OEM/ODM welcome



IP55/IP65 Waterproof Grade



PCAP touch technology
optional



Flexible modules optional



Single side double side
optional



OUTDOOR DIGITAL TOTEM

Size: 32" - 98"

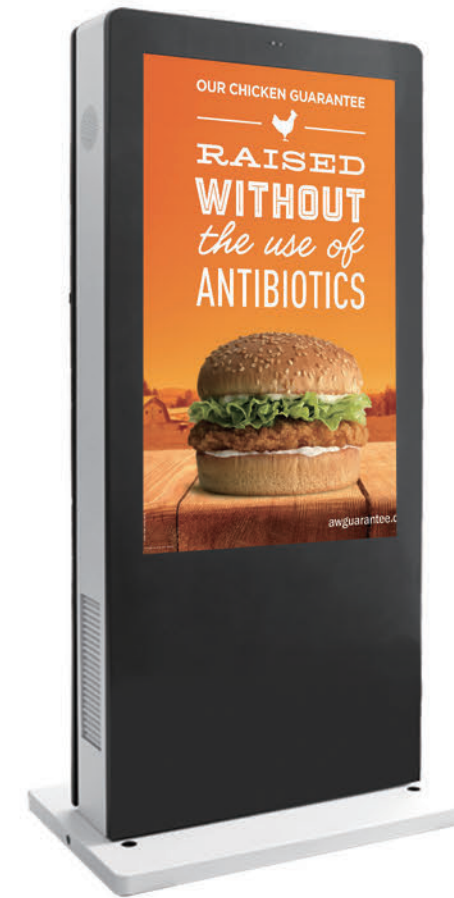

2000-3500nits
brightness panel



Android/Windows OS
optional



-40 C- 55 C working condition

OEM/ODM

OEM/ODM welcome



IP55/IP65 Waterproof Grade



PCAP touch technology
optional



Flexible modules optional



Single side double side
optional



OUTDOOR DIGITAL TOTEM

Size: 32"- 98"



2000-3500nits
brightness panel



Android/Windows OS
optional



-40 C- 55 C working condition

OEM/ODM

OEM/ODM welcome



IP55/IP65 Waterproof Grade



PCAP touch technology
optional



Flexible modules optional



Single side double side
optional



BATTERY DRIVE OUTDOOR DIGITAL TOTEM

Size: 32", 43", 49", 55", 65"



2000-3500nits
brightness panel



Android/Windows OS
optional



-40 C- 55 C working condition

OEM/ODM

OEM/ODM welcome



IP55/IP65 Waterproof Grade



PCAP touch technology
optional



A/C power free



Single side double side
optional



OUTDOOR DIGITAL TOTEM

Size: 18.5" - 98"



2000-3500nits
brightness panel



Android/Windows OS
optional



PCAP touch technology
optional

OEM/ODM

OEM/ODM welcome



-40 C- 55 C working condition



IP55/IP65 Waterproof Grade



Flexible modules optional



Single side double side
optional

Outdoor digital totem frame options



1, Appearance, structure and border color can be customized.

2, Multiple sizes can be chosen.(18.5",21.5",,32",43",49",55",65",70",75",82",85",98")

3, More Brightness and modules optional, wheels optional , OEM/ODM welcome.

4, Andriod OS support Google store, HDMI input.

5, Windows: i3 i5 i7 various generations available.



FSD | Free standing display mounts to solid ground

UMD | Universal Mount Display mounts on any side

PDM | Panel Display Module mounts onto an existing structure



Heat & Sun

- Up to 3500 nit Brightness
- -40 C to +50 C
- Closed Loop Cooling
- Anti-Reflective Glass'
- Dynamic Dim LEDs
- Sunglass Viewable



Protection

- IP 65 Design
- 13.5mm Cover Glass
- Robust Materials
- Auto-Prevention of Tripped Circuits



Energy

- Low Energy Consumption
- 120 V / 20 A
- High Efficiency LEDs
- Eco-Friendly Design



Plug & Play

- Configured IP
- Image Media Player
- Install Software
- Pre-load Content
- Connect to NOC



Monitoring

- Temperature Control
- Player/Video Status
- Run Time Statistics
- Backlight Status
- Remote Re-boot



Servicing

- Service Unit in installed Position
- Modular Design to Reduce Service Time
- Technical Support

Options

Touchscreen, Speakers
Camera, NFC, Beacon

Resolution & Sizes

Full HD (1920 x 1080): 19" - 98"
Ultra HD (3840 x 2160): 58", 65", 84", 98"

Configurations

Single / Double Sides
Landscape / Portrait Orientation

Applications

Transit | Street Furniture | QSR | Stadium | Retail | C-Store | Hospitality



STRETCHED LCD DISPLAY

Size: 16.4" - 60"

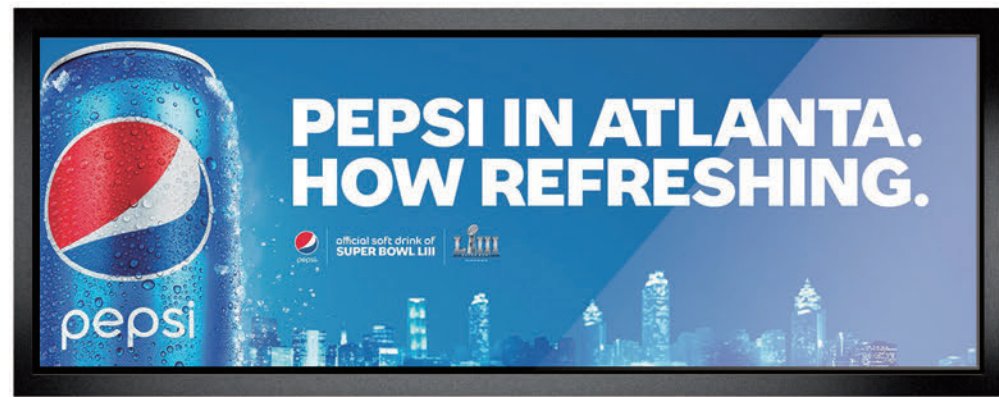

FHD screen



Multiple screens



Multiple sizes available



Horizontal screen/
vertical screen



Ultra stretched



Android/Windows OS
optional



Cloud CM,S management

24hr

7x24 hours
(Working time)

SHELF LCD SCREEN

Size: 16.4" - 60"



LG/SAMSUNG FHD screen



Android/Windows OS
optional



Cloud CM,S management



Multiple screens



Ultra stretched



Horizontal screen/
vertical screen



Multiple sizes available

24hr

7x24hours
(Working time)

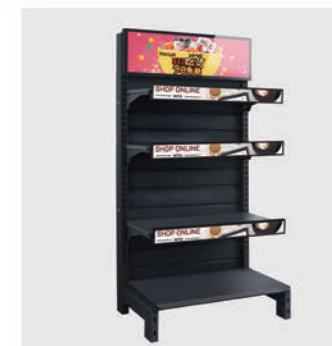

STRETCHED BAR LCD FEATURES

1 Sleek Design for Space

Ultra-Stretch Signage delivers seamless content as an in-store signboard, digital banner and more, thanks to its generous aspect ratio. Installed on a wall, on a pillar or perhaps over the entrance, it adds premium style while uniquely engaging with all who behold its striking form factor.



2 PBP with Four Divisions in Landscape or Portrait

The Picture-by-Picture (PBP) feature allows you to divide a screen into up to four parts, in landscape or portrait installations. It is a very effective and convenient way to deliver several advertisements or pieces of information at the same time.



3 Multimedia Content Creation

Combine video with up to 20 still photos in a single piece of content for an engaging new multimedia presentation.



4 Lateral Tiling with Daisy Chain

This product supports side-by-side tiling for 1x4 or 4x1 installations (landscape or portrait orientation) and up to a 4x4 installation with a daisy chain configuration.



5 LAN Daisy Chain

Control and monitor devices, distribute content and even update firmware over the LAN daisy chain.

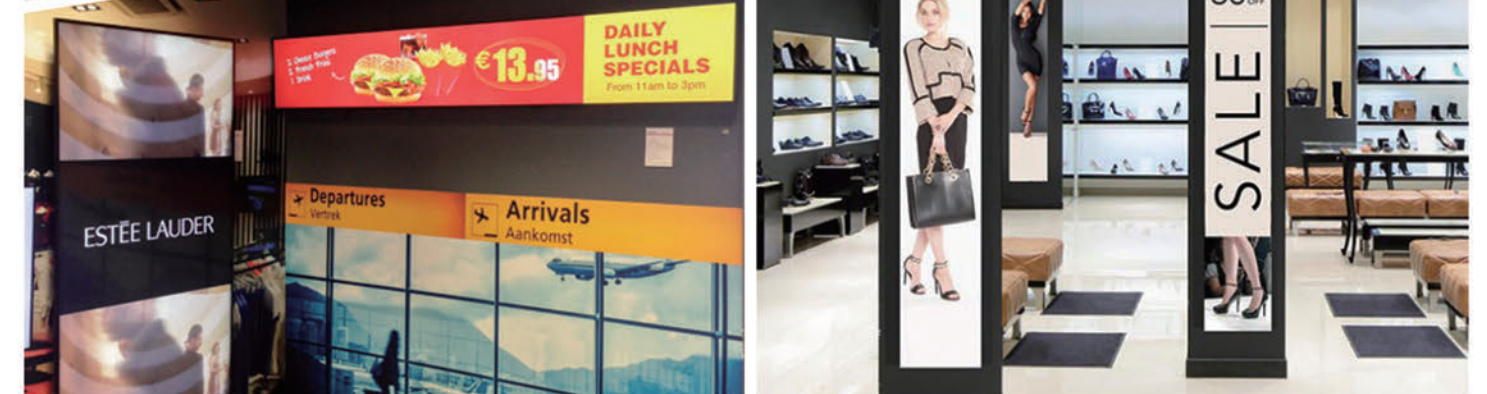



Boutique store in Italy
4x2 55" 3.5mm bezel video wall



FOXCONN video conference center
2x2+3x9+2x2 60" video wall



Spain Carrefour supermarket
200sets door open digital totem



Telecom information center
55" customized touch screen kiosk

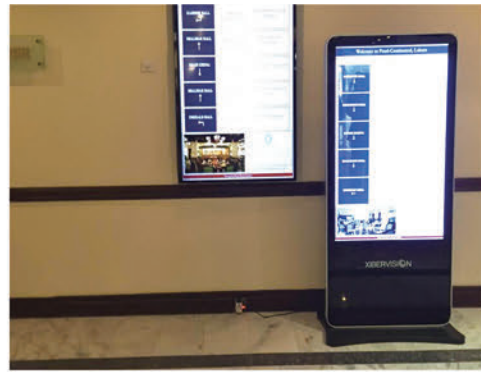

Pakistan KHI airport digital kiosk
100sets Android digital signage



AUTO 4S store information kiosk
55" floor stand with customized stand



Bus station multimedia self-service terminal
65" Fan cooling with Dome camera touch screen



School information display terminal
70" 10dots Nano touch screen



Clothing store Bar LCD display wall
49.5" Ultra stretched embed with furniture



GIADA Suzhou Shopping mall boutique
4x1 55" 3.5mm bezel video wall

 DESIGN

We conduct research; define strategy, and design brands and interfaces that meet our clients' goals. Every project is different; that's why we enjoy client services. Clients benefit from our years of experience, and we never stop learning.

 CUSTOMIZATION

Flexibility is our specialty. We develop high-level concepts for the structure, interaction, and visual edge. We modify, build and design according to the needs of the clients.

 DELIVERY

We provide safe and fast delivery of products nationwide and abroad. Rest assured that the purchased items are carefully handled by our team.

 INSTALLATION

Our in-house engineers and technical support team are trained worldwide. They are experts in their field, proven and tested throughout the years.

 CONTENT CREATION & MANAGEMENT

Our design team endows diversified thinking, unique taste and passion for artistry, all combined to give you the top-quality content best fit for your display.

 AFTER-SALES SERVICE

We provide quality after-sales service and maintenance. Our team makes sure that every project is well maintained, checked and tested. We also provide 24/7 hotline service worldwide.

COOPERATION BRANDS



COMPANY HONORS



CONTACT US

Headquarters:

Address: 3/F, No.5,Intelligent Creation Park,Yabian community,Shajing, Baoan,Shenzhen,China 518104

General manager: Steven Cheung

Mobile/WhatsApp/Wechat: +86 134 1755 8100

Skype: brightsteve

Email: info@ddw.net

Homepage: www.ddw.net

Digital signages: www.digitalsignages.com

LCD video wall+controller: www.ddwlcdivideowall.com

LED displays: www.ddwled.com

